

PARTNER® Szmids-Banyś Sp.J.
41-910 Bytom ul. Chorzowska 30c tel. 32 733 7999
www.partner-med.pl www.kuschall.eu
Autoryzowany przedstawiciel marki Invacare i Kuschall

<p>Invacare® Action³ Junior Evolutive CE</p> <p>The product includes all standard features Maximum User Weight: 80kg</p> <p>Standard Base Price: 5200 PLN</p>	<p>Company Stamp</p> <p>Reference</p>
---	--

Please make your selection with a cross in the box ◆ Standard feature ○ Free of Charge (NC 9999) = not compatible with ref 9999

Code	Description	Nc	€
Model			
CNC0001	Action³ junior evolutive		
CNCspec	Special		on request
Propulsion type			
CNC0100	Self propulsion	(Nc : 1100, 1110, 1170)	◆
CNC0110	Transit propulsion (seat angle 1,5° only) with rh tipping aid	(Nc : 0280, 1060, 1070, 1075, 1090, 1180, 1190, 1195, 1275, 1375, 1390, 1430, 1440)	153,00
Seat			
<i>Evolutive seat version</i>			
Telescopic crossbar short for seat width 205 to 280 mm and seat depth 200 to 350 mm			
Seat width			
CNC0140	205 mm seat width, including stabiliser kit (0881), Only available with option 0611	(Nc: 0170, 0171, 0480, 0511, 0513, 0520, 0530, 0561, 0563, 0570, 0580, 0890, 0900, 1375)	○
CNC0141	230 mm seat width, including stabiliser kit (0881), Only available with option 0611	(Nc: 0170, 0171, 0480, 0511, 0513, 0520, 0530, 0561, 0563, 0570, 0580, 0890, 0900, 1375)	○
CNC0142	255 mm seat width, including stabiliser kit (0881)	(Nc: 0170, 0171, 0480, 0511, 0513, 0520, 0530, 0561, 0563, 0570, 0580, 0600, 0610, 0620, 0630, 0890, 0900, 1375)	○
CNC0143	280 mm seat width, including stabiliser kit (0881)	(Nc: 0170, 0171, 0480, 0511, 0513, 0520, 0530, 0561, 0563, 0570, 0580, 0600, 0610, 0620, 0630, 0890, 0900, 1375)	○
Seat depth			
CNC0160	Adjustable seat depth 200 to 250 mm, delivered at 230 mm	(Nc: 1060, 1070, 1075)	○
CNC0161	Adjustable seat depth 250 to 300 mm, delivered at 280 mm		○
CNC0162	Adjustable seat depth 300 to 350 mm, delivered at 330 mm		○
Telescopic crossbar long for seat width 305 to 380 mm and seat depth 275 to 375 mm			
Seat width			
CNC0150	305 mm seat width	(Nc: 0160, 0161, 0162, 0520, 0570, 0890)	○
CNC0151	330 mm seat width	(Nc: 0160, 0161, 0162, 0530, 0580, 0900)	○
CNC0152	355 mm seat width	(Nc: 0160, 0161, 0162, 0530, 0580, 0900)	○
CNC0153	380 mm seat width	(Nc: 0160, 0161, 0162, 0530, 0580, 0900)	○









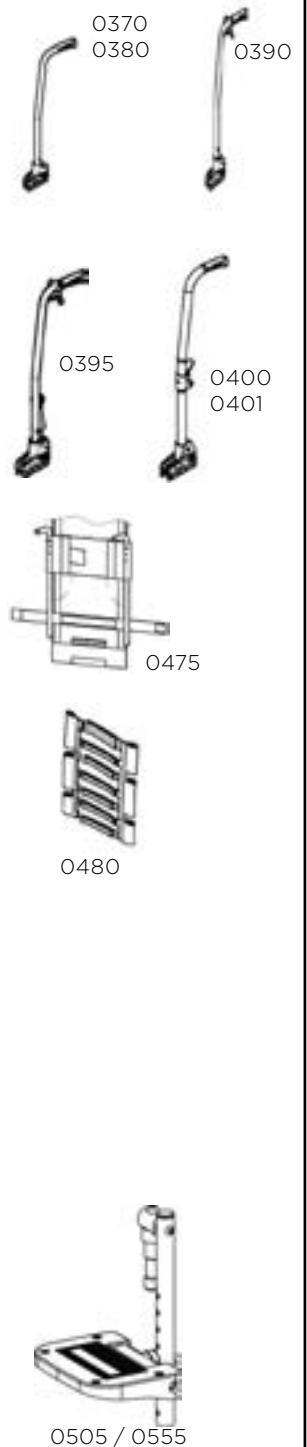



Important Information:
Stabiliser kit (see seating option type; ref. 0881) is a standard feature for a better front and lateral stability for these seat widths.



Seat depth			
CNC0170	Adjustable seat depth 275 to 325 mm, delivered at 300 mm		○
CNC0171	Adjustable seat depth 325 to 375 mm, delivered at 350 mm		○
Seat height			
CNC0260	460 mm seat height		○
CNC0270	435 mm seat height		○
CNC0280	410 mm seat height	(Nc: 1375, 1430, 1440)	○
Seat upholstery type			
CNC0335	Nylon with velcro strips seat upholstery, width & depth adjustable		◆
Backrest			
Backrest type			
CNC0370	Fixed 0° backrest 3 heights: 370/400/430 mm - delivered at 370 mm (sw 205 to 280 mm) at 400 mm (sw 305 to 380 mm)		○
CNC0380	Fixed 7° backrest 3 heights: 370/400/430 mm - delivered at 370 mm (sw 205 to 280 mm) at 400 mm (sw 305 to 380 mm)		◆
CNC0381	Fixed 7° backrest 510 mm, 3 heights: 370/400/430 mm - delivered at 370 mm (sw 205 to 280 mm) at 400 mm (sw 305 to 380 mm)		○
CNC0390	Reclining (ratchet) 0/30° backrest 5 heights: 350/370/390/410/430 mm - delivered at 370 cm (sw 205 to 280 mm) at 390 mm (sw 305 to 380 mm) w/o backbrace	(Nc: 1190, 1195)	156,00
CNC0395	Reclining (gas spring) 0/30° backrest 400 mm height w/o backbrace	(Nc: 1190, 1195)	282,00
CNC0400	Folding backrest 3 heights: 370/400/430 mm - delivered at 370 mm (sw 205 to 280 mm) at 400 mm (sw 305 to 380 mm)		116,00
CNC0401	Folding backrest 51 cm, 2 heights: 400/430 mm - delivered at 400 mm		119,00
CNC0402	Folding backrest, 2 heights: 380/500 mm - delivered at 500 mm; height adjustable pushhandle rear set (150 mm); including back brace	(Nc: 0480, 0855, 0902, 1426)	195,00
CNC0420	Folding backrest 400 mm height; height adjustable pushhandle (430 to 530 mm)	(Nc: 0855)	166,00
Backrest upholstery type			
CNC0475	Width & height adjustable nylon sling type		◆
CNC0480	Contour (tension) adjustable nylon type	(Nc: 0855)	166,00
Hangers/footplates			
Hangers rh type (height adj. By step of 10 mm)			
CNC0505	90° Straight rh removable hanger ul std 125 to 260 mm	(Nc: 0600, 0610, 1005)	○
CNC0510	80° Short rh swing in/out hanger 0° standard position; ul std 220 to 320 mm	(Nc: 0561, 0562, 0563, 0610)	◆
CNC0511	80° Short rh swing in/out hanger 30° abduction position; ul std 220 to 320 mm	(Nc: 0560, 0562, 0563, 0610, 0611, 0881)	○
CNC0512	80° Long rh swing in/out hanger 0° standard position; ul std 300 to 450 mm	(Nc: 0560, 0561, 0563, 0610)	○
CNC0513	80° Long rh swing in/out hanger 30° abduction position; ul std 300 to 450 mm	(Nc: 0560, 0561, 0562, 0610, 0611, 0881)	○
CNC0520	Elevating legrest (0° to 80°) rh swing in/ swing out hanger (including calfpad); ul std 275 to 375 mm	(Nc: 0600, 0611, 0880, 0886)	110,00
CNC0530	"Elevating legrest (0° to 80°) rh swing in/ swing out hanger (without calfpad, with calfstrap); ul std 235 to 295 mm ! Only for seat width 305 mm !"	(Nc: 0600, 0611, 0880, 0886)	115,00
Hangers lh type (height adj. By step of 10 mm)			
CNC0555	90° Straight lh removable hanger; ul std 125 to 260 mm	(Nc: 0620, 0630, 1005)	○



CNC0560	80° Short lh swing in/out hanger 0° standard position; ul std 220 to 320 mm	(Nc: 0630)		◆	 0510 / 0560
CNC0561	80° Short lh swing in/out hanger 30° abduction position; ul std 220 to 320 mm	(Nc: 0611, 0630, 0881)		○	
CNC0562	80° Long lh swing in/out hanger 0° standard position; ul std 300 to 450 mm	(Nc: 0630)		○	
CNC0563	80° Long lh swing in/out hanger 30° abduction position; ul std 300 to 450 mm	(Nc: 0611, 0630, 0881)		○	
CNC0570	Elevating legrest (0° to 80°) lh swing in/ swing out hanger (including calfpad); ul st 275 to 375 mm	(Nc: 0611, 0620, 0880, 0886)	110,00		
CNC0580	"Elevating legrest (0° to 80°) lh swing in/ swing out hanger (without calfpad, with calfstrap); ul std 235 to 295 mm ! Only for seat width 305 mm !	(Nc: 0611, 0620, 0880, 0886)	115,00		 0520 + 0610 0570 + 0630
Footplates rh type					
CNC0600	Flip up rh footplate (including heel strap)	(Nc: 0883, 0884, 0885, 0886)		◆	 0520 + 0610 0570 + 0630
CNC0605	Flip up, angle & depth adjustable rh footplate (including heel strap)		59,00		
CNC0610	"Flip up and angle adjustable rh footplate ! Only with elevating legrests (0520, 0530, 0570, 0580) ! (Including heel strap)"	(Nc: 0883, 0884, 0885, 0886)	48,00		
CNC0611	One piece footboard	(Nc: 0620, 0625, 0630, 0883, 0884, 0885)	189,00		 0611
Footplates lh type					
CNC0620	Flip up lh footplate (including heel strap)	(Nc: 0883, 0884, 0885, 0886)		◆	 0605 / 0625
CNC0625	Flip up, angle & depth adjustable lh footplate (including heel strap)		59,00		
CNC0630	Flip up and angle adjustable lh footplate ! Only with elevating legrests (0520, 0530, 0570, 0580) ! (Including heel strap)	(Nc: 0883, 0884, 0885, 0886)	48,00		 0611
Armrests					
Armrests rh form					
CNC0640	Removable rh (n°1) autolock safety device included desk std armpad (60 mm) adj. 180 To 280 mm	(Nc: 0745, 0746, 0750, 0755)		◆	 0640/ 0740
CNC0645	Removable rh (n°1) autolock safety device included junior std armpad (60 mm) adj. 150 To 250 mm	(Nc: 0740, 0750, 0755)		○	
CNC0646	Removable rh (n°1) autolock safety device included narrow armpad junior (50 mm), narrow armpad junior (50 mm)	(Nc: 0740, 0745, 0750, 0755, 1470)		○	
CNC0650	Mudguard rh height adjustable (155 to 220 mm)	(Nc: 0740, 0745, 0755, 1201, 1471, 1472)		○	
CNC0655	Skirtguard rh junior	(Nc: 0740, 0745, 0750, 1471, 1472)		○	
Armrests lh form					
CNC0740	Removable lh (n°1) autolock safety device included desk std armpad (60 mm) adj. 180 To 280 mm			◆	 0645/ 0745
CNC0745	Removable lh (n°1) autolock safety device included junior std armpad (60 mm) adj. 150 To 250 mm			○	
CNC0746	"Removable lh (n°1) autolock safety device included narrow armpad junior (50 mm), adj. 150 To 250 mm	(Nc: 1470)		○	
CNC0750	Mudguard lh height adjustable (155 to 220 mm)	(Nc: 1201, 1471, 1472)		○	
CNC0755	Skirtguard lh junior	(Nc: 1471, 1472)		○	
Seating options type					
CNC0851	Seat cushion mss (essential junior)		95,00		 0851
CNC0855	Backrest extension (230 mm)	(Nc: 0860, 0865)	159,00		 0860
CNC0860	Headrest standard multi - adjustable, including adjustable backbrace	(Nc: 0865)	316,00		

CNC0865	Headrest round multi - adjustable, including adjustable backbrace			495,00
CNC0880	Adjustable calf strap			19,00
CNC0881	Front stabiliser kit, + 100 mm outward			92,00
CNC0883	Ankle grips "xs", pair including bracket strap's circumference 155 to 200 mm		Only available with footplate 0605/0625	215,00
CNC0884	Ankle grips "s", pair including bracket strap's circumference 160 to 215 mm		Only available with footplate 0605/0625	215,00
CNC0885	Ankle grips "m", pair including bracket strap's circumference 175 to 230 mm		Only available with footplate 0605/0625	215,00
CNC0886	Footplate adjustment optimizer kit, (front or rear set adjustment)			59,00
CNC0902	Width adjustable back brace			59,00
Colours				
CNA0952	Pearl white			○
CNA0953	Matt black			○
CNA0954	Matt red			○
CNA0955	Intense yellow			○
CNA0956	Polar blue			○
CNA0957	Candy pink			○
Front wheels				
CNC1000	125 X 25 mm (5" x 1") solid tyre			◆
CNC1001	125 X 25 mm (5" x 1") flashing lights solid tyre			○
CNC1005	125 X 45 mm (5" x 1" 3/4) solid tyre			○
Rear wheels				
Rear wheel type				
CNC1060	560 X 35 mm (22" x 1.3/8") Pneumatic tyre spoked rim	(Nc: 1170)		◆
CNC1070	555 X 35 mm (22" x 1.3/8") Solid tyre spoked rim	(Nc: 1170)		○
CNC1075	550 X 25 mm (22" x 1.3/8") Black solid tyre spoked rim	(Nc: 1170)		○
CNC1090	515 X 35 mm (20" x 1.3/8") Solid tyre spoked rim	(Nc: 1170, 1280)		○
CNC1100	305 X 50 mm (12" x 2") pneumatic tyre plastic rim	(Nc: 1140, 1141, 1180, 1253, 1254, 1255, 1256, 1380, 1390)		○
CNC1110	305 X 45 mm (12" x 2") solid tyre plastic rim	(Nc: 1140, 1141, 1180, 1253, 1254, 1255, 1256, 1380, 1390)		○
Handrim type				
CNC1140	Aluminium pre-anodized handrim			◆
CNC1141	Handrim coated in black anti-slip plastic			79,00
Rear wheels axle type				
CNC1170	Fixed axle			○
CNC1180	Quick release axle			◆
Rear wheels position				
CNC1190	Standard rear wheels position (25 mm frontward / backrest cane axle)			○
CNC1195	Medium rear wheels position (on line / backrest cane axle)			○
CNC1200	Passive rear wheels position (25 mm backward / backrest cane axle)			◆
Pump				
CNC1230	Pump and support			10,00
Chassis options type				
CNC1253	Spoke guard clear, pair			166,00
CNA1254	Spoke guards pixel; pair			210,00
CNA1255	Spoke guards snowflakes; pair			210,00
CNA1256	Spoke guards color mel; Pair			210,00

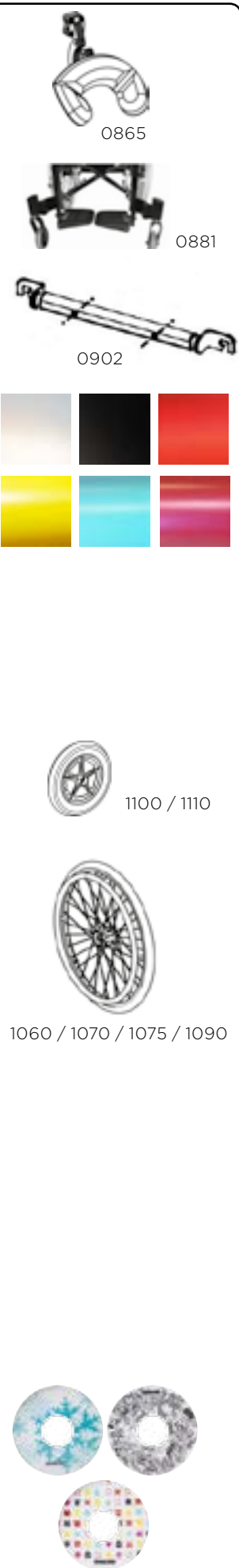

Brakes type				
CNC1270	Push to lock brakes			○
CNC1275	Pull to lock brakes			◆
CNC1280	Attendant hub brakes (including push to lock brakes)	(Nc: 1426)		209,00
Safety options type				
CNC1345	Transportation kit including posture belt	(Nc: 1360)		74,00
CNC1360	Posture belt			59,00
CNC1361	Pediatric belt			100,00
CNC1370	Rear anti-tippers pair with tipping aid	(Nc: 1430, 1440)		71,00
CNC1375	Transfert kit (100 mm (4") wheels) anti-barrier			90,00
CNC1380	Reflectors kit (for spoke wheels only)			◆
CNC1390	Brake extension pair			26,00
Attendant options type				
CNC1426	Stroller push handles pair multi-angle adjustable			165,00
CNC1430	Rh tipping aid			19,00
CNC1440	Lh tipping aid			19,00
Accessories type				
CNC1471	Rh swing away acrylic tray			315,00
CNC1472	Lh swing away acrylic tray			315,00
Total price				

